

Novelty!

Harvia Globe electric sauna heater



HARVIA
Natural well-being.



Harvia Globe sauna heater GL70, stand, safety railing and bench protection glass



Harvia Globe sauna heater GL110, ceiling suspension kit, safety railing and bench protection glass



Harvia Globe sauna heater GL70 and wall mounting rack



NOVELTY!

Harvia Globe – A sauna heater of endless possibilities

Harvia Globe sauna heater offers you a pleasant bathing experience, not only through heat and steam, but also through its unique design and excellent usability. Cast out your preconceptions about the position of the heater in a sauna! The Harvia Globe can be positioned on a wall, on a stand or even hung from the ceiling. This freedom of choice also lets your imagination run wild when planning the bench layout for your sauna.

Harvia Globe is also an example of environmentally friendly design: The finest raw material – sturdy stainless steel – is used by producing as little waste as possible and no harmful chemicals are used in its surface finish. A completely new way of thinking is also apparent in the design of the heater, which is made out of precisely laser-cut steel arches and rings. The amount of sauna stones is carefully optimized: The heater heats up quickly without sacrificing the softness of the steam.

Harvia Globe heaters GL70 (Ø 430 mm) and GL110 (Ø 500 mm) are controlled with a touch-screen control panel. The user-friendly touch-screen control panel with a highly accurate temperature adjustment has been designed for your convenience according to Harvia's design principles. The simple and stylish control panel can be installed in the sauna room itself or in a dry space. The heater includes a compact power unit, which provides electricity to the heating elements. The heater is connected to the power unit via a cable running inside an armored tube. The heater's temperature sensor is installed in the ceiling of the sauna room and connected to the power unit via a cable.

Harvia Globe is also available as E models GL70E and GL110E, which are controlled with a separate control unit (for example Griffin or C150). The E models include a connection box for electrical input from the control unit. The heater is connected to the connection box via a cable running inside an armored tube.



GL70





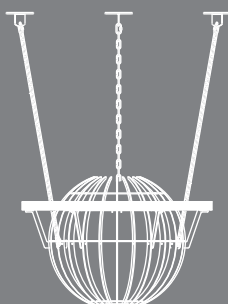
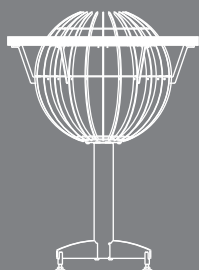





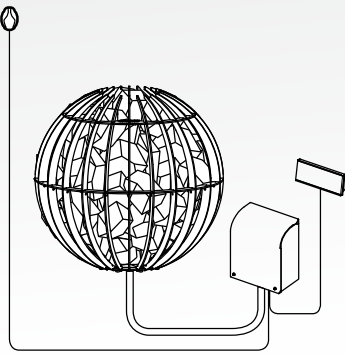

GL110





Choosing Globe heater, fastening kit and accessories

Heater	Fastening kit	Safety railing Optional	Bench protection Optional
 <p>Harvia Globe GL70 (6,9 kW) ø 430 mm</p> <p>Harvia Globe GL110 (10,5 kW) ø 500 mm</p>	 <p>Ceiling suspension kit HGL4</p>	 <p>Safety railing HGL6 (Globe 6,9 kW) HGL7 (Globe 10,5 kW)</p>	 <p>Bench protection glass HGL8</p>
	 <p>Stand telescopic HGL3</p>  <p>Stand low HGL5</p>	 <p>Safety railing HGL6 (Globe 6,9 kW) HGL7 (Globe 10,5 kW)</p>	 <p>Bench protection glass HGL8</p>
	 <p>Wall mounting rack HGL1 (Globe 6,9 kW) HGL2 (Globe 10,5 kW)</p>	 <p>Safety railing HGL6 (Globe 6,9 kW) HGL7 (Globe 10,5 kW)</p>	

Technical data

Heater model	Power kW	Recommended sauna room size min.-max. m ³	Sauna room height min. mm	Stone capacity max. kg	Diameter mm	400 V 3N-Connecting cables mm ²	Fuse A
Globe 70	6,9	6-10	1900	50	430	5 x 1,5	3 x 10
Globe 70E	6,9	6-10	1900	50	430	5 x 1,5	3 x 10
Globe 110	10,5	9-15	1900	80	500	5 x 2,5	3 x 16
Globe 110E	10,5	9-15	1900	80	500	5 x 2,5	3 x 16

Globe heater GL70 dimensions: width 430 mm, depth 430 mm, height 395 mm, weight 10 kg
 Globe heater GL110 dimensions: width 500 mm, depth 500 mm, height 475 mm, weight 14 kg

Safety distances

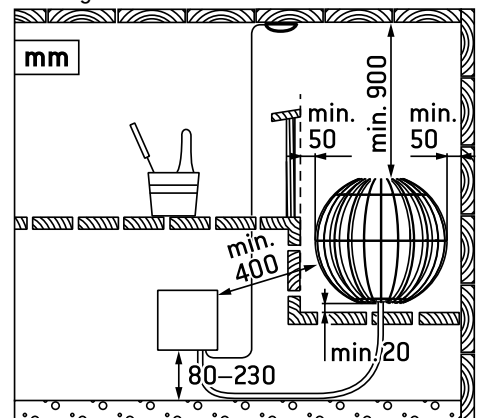

Local dealer:

HARVIA
Natural well-being.

Contact information:

Harvia Ltd., P.O. Box 12, FI-40951 Muurame, FINLAND
 Tel. +358 207 464 000, Fax +358 207 464 090
 harvia@harvia.fi, www.harviasauna.com